

## I . Function (figure 1)

1. Head shower
2. Massage jet
3. Hand shower
4. Diverter:4-ways
5. Thermostatic mixer
6. Spout

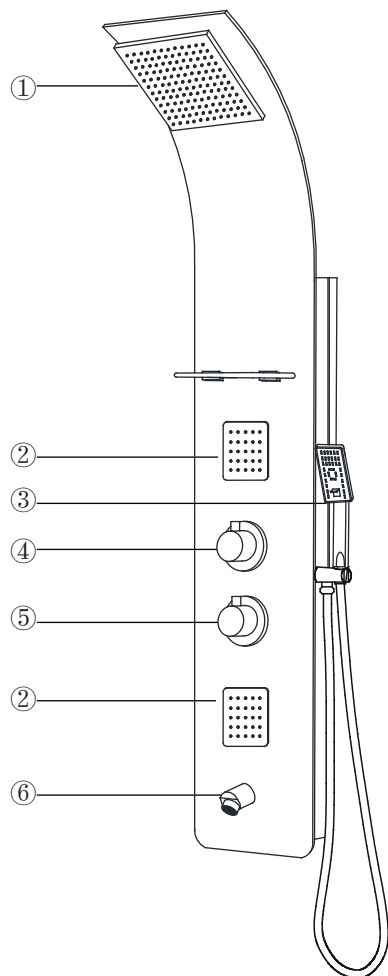

## II . installation (figuer 2 & figuer 3)

Note! Before drilling any hole for fixing your shower panel esure that there are no hidden cables or pipework within the wall

### I . Drill the holes in the wall

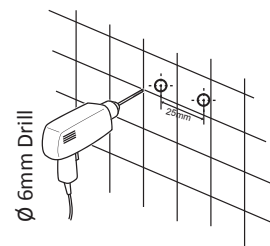

### II . insert the wall plugs inside the holes

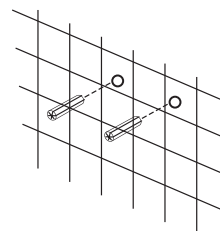

### III . Tighten the screws to the wall with wall mounting brackets

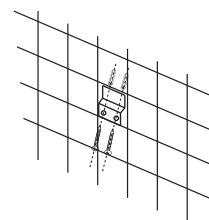

### Wall-mounting

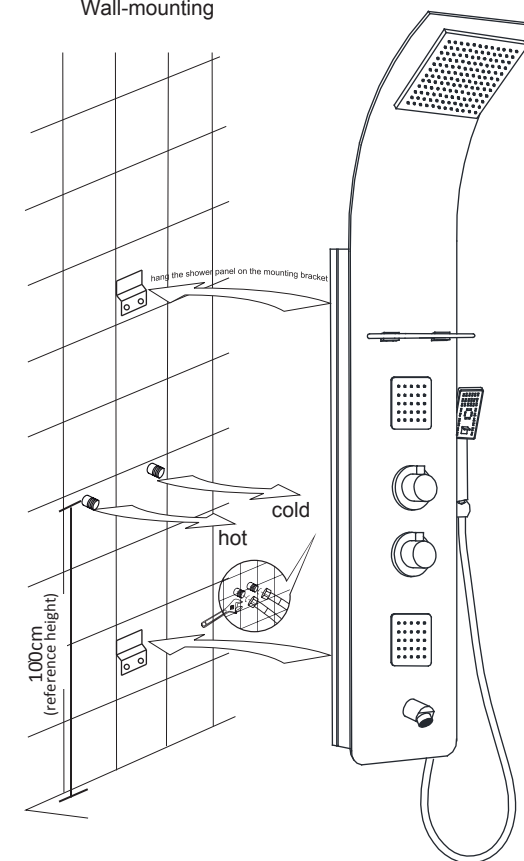

## Package Include:

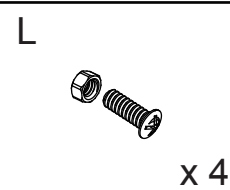
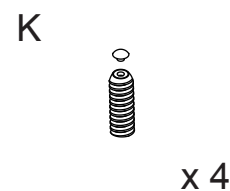
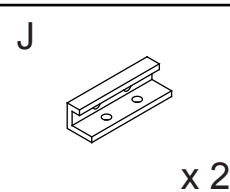
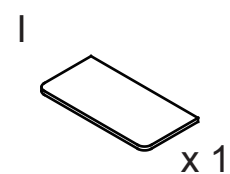
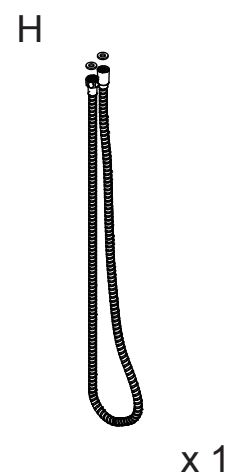
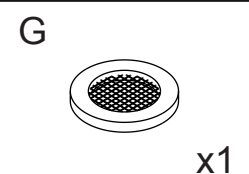
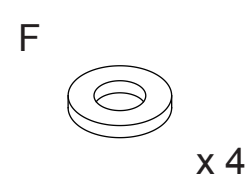
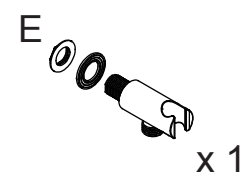
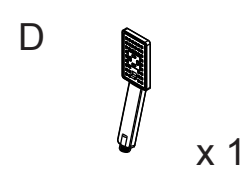
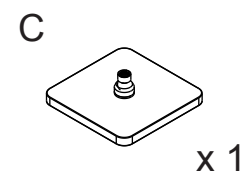
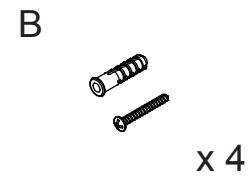
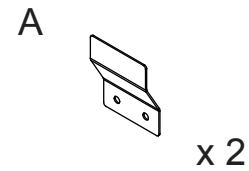
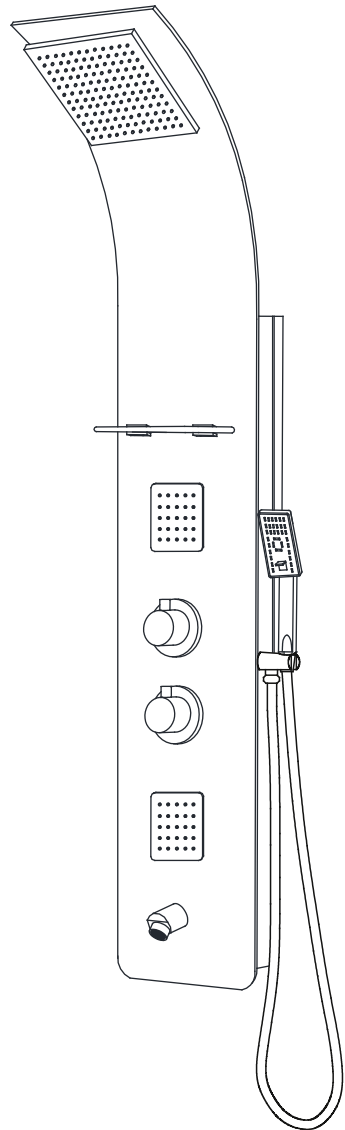

## Tools request:

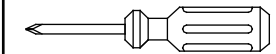
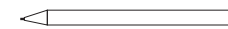
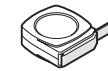
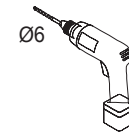

### ※ IMPORTANT maintenance:

1. After shower, clean with running water, then use a soft and dry cloth to make the shower panel dry.

2. Often ventilate the bathroom, keep the room dry.

3. Never use acids, harsh chemicals, or abrasive detergents as they may damage the finish. Failure to comply with manufacturer's recommendations may void the warranty.

4. We suggest ideal water pressure should at least 2 bar.

\* Using soft water, no acidic, mild cleaner.