

## I. 기능 (그림 1)

1. 헤드 샤워
2. 마사지 제트
3. 핸드 샤워
4. 전환 장치: 4방향
5. 온도 조절 믹서
6. 꼭지

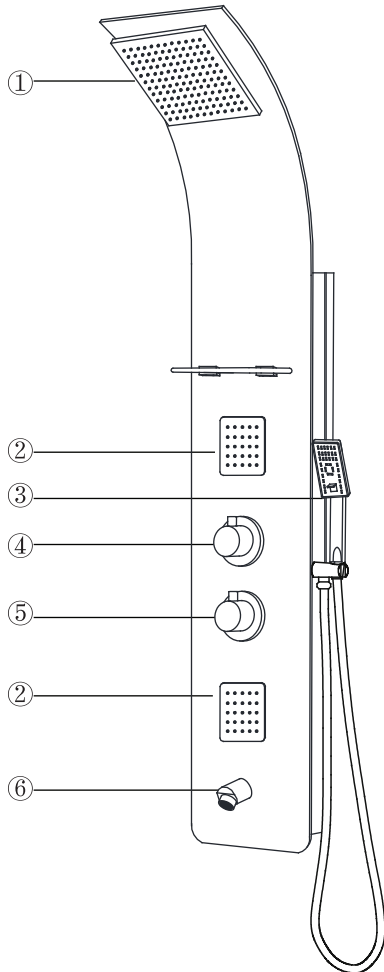

## II. 설치 (그림 2 및 그림 3)

**참고!** 샤워 패널을 고정하기 위한 구멍을 뚫기 전에 벽 안에 숨겨진 케이블이나 배관이 없는지 확인하십시오.

### I. 벽에 구멍 뚫기

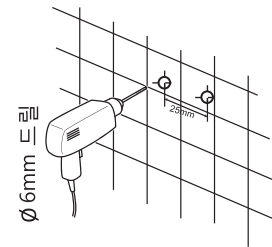

### II. 구멍 안에 벽 플러그를 꽂습니다.

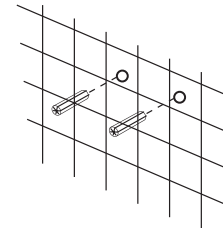

### III. 벽걸이 브래킷을 사용하여 나사를 벽에 채웁니다.

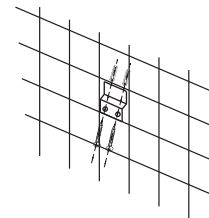

### 벽걸이형

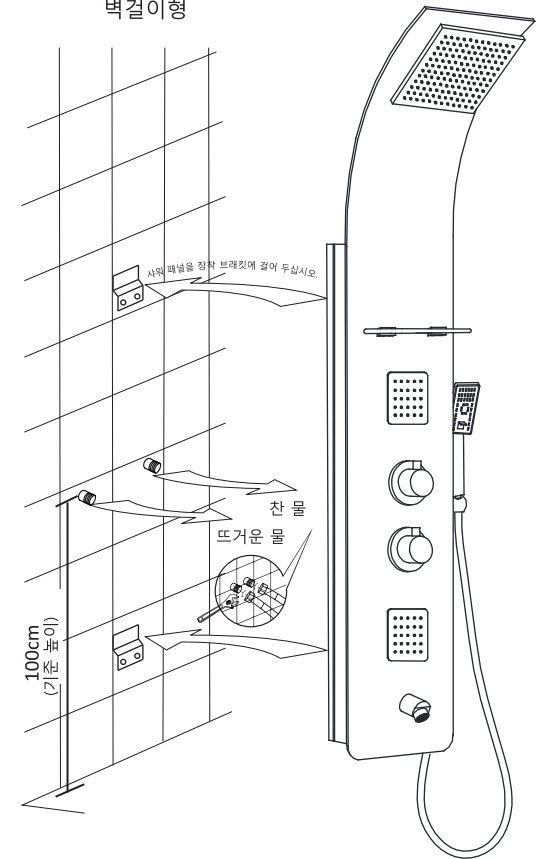

패키지 내용물:

공구 요구사항:

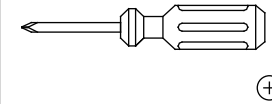
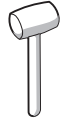
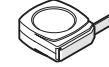
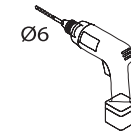
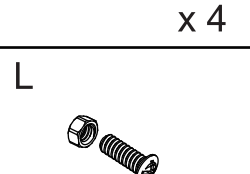
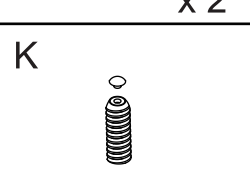
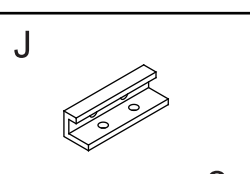
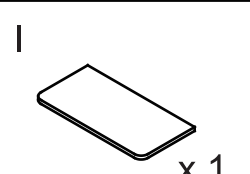
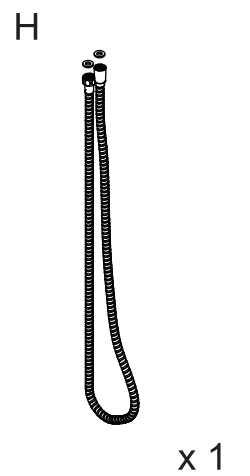
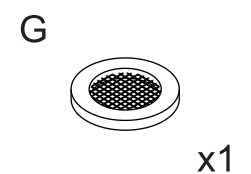
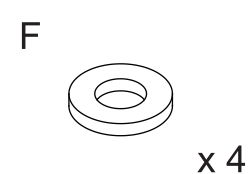
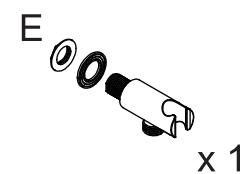
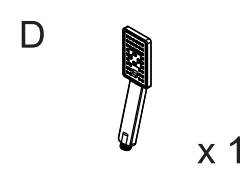
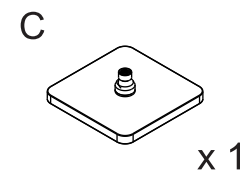
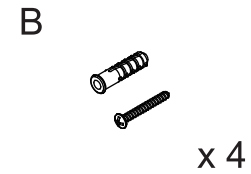
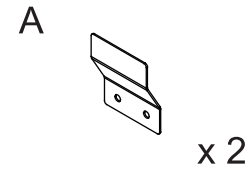
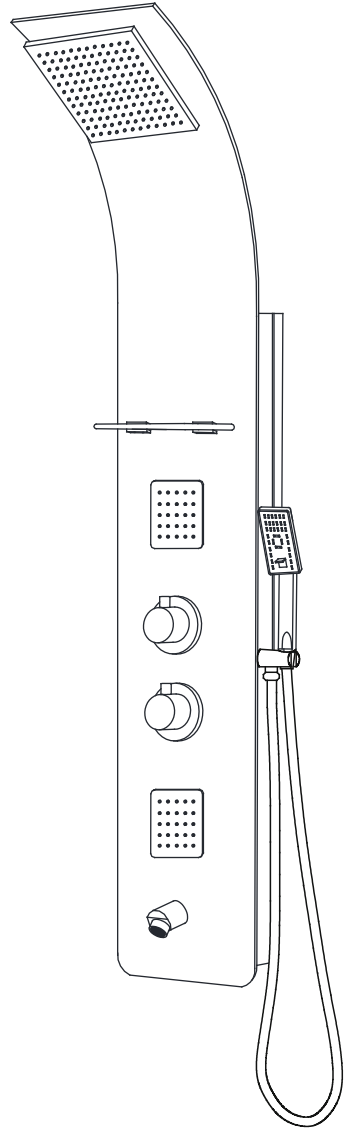

※ 중요 유지관리:

1. 샤워 후 샤워 패널을 흐르는 물로 씻은 후 부드럽고 마른 천을 사용하여 닦아냅니다.
2. 욕실을 자주 환기시키고 건조하게 유지하십시오.
3. 산, 유독성 화학 물질 또는 연마성 세제는 마감 재료를 손상시킬 수 있으므로 절대 사용하지 마십시오. 제조업체의 권장 사항을 준수하지 않을 경우 보증이 무효화될 수 있습니다.
4. 권고하는 이상적인 수압은 최소 2bar여야 합니다.

\*연수, 산성이 없는 순한 세정제 사용.